

Inductive sensors special versions

IFRD 08

sample drawing

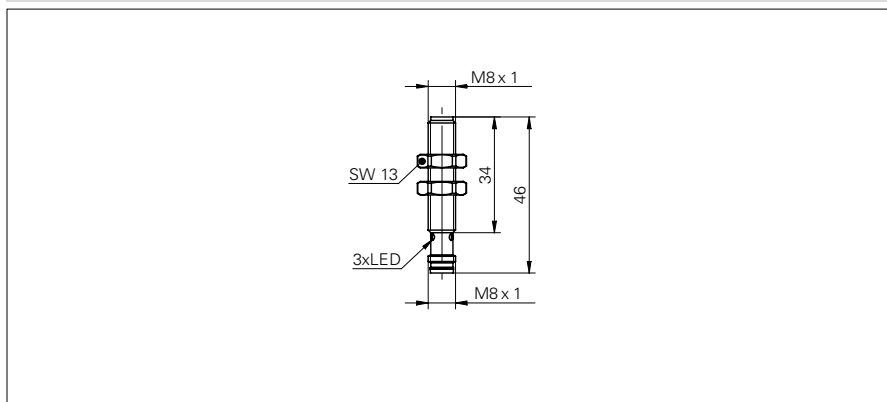

general data

mounting type	quasi shielded
special type	full metal housing (DuroProx)
nominal sensing distance S_n	2 mm
hysteresis	2 ... 20 % of S_r

electrical data

switching frequency	< 150 Hz
voltage supply range +Vs	10 ... 30 VDC
current consumption max.	20 mA
voltage drop V_d	< 2 VDC
short circuit protection	yes
reverse polarity protection	yes

mechanical data

type	cylindrical threaded
material (sensing face)	stainless steel 1.4404 (V4A)
housing material	stainless steel 1.4404 (A4)
pressure static	< 20 bar
dimension	8 mm
housing length	46 mm
connection types	connector M8

sample picture



order reference	output circuit	operating temperature	protection class	output indicator	output current
IFRD 08N17A1/S35L	NPN make function (NO)	-25 ... +75 °C	IP 68/67 (sensing face/sensor)	3 port LED red	< 200 mA
IFRD 08N17T1/S35	NPN make function (NO)	-25 ... +100 °C	IP 69K (sensing face/sensor)	-	< 100 mA
IFRD 08N37A1/S35L	NPN break function (NC)	-25 ... +75 °C	IP 68/67 (sensing face/sensor)	3 port LED red	< 200 mA
IFRD 08N37T1/S35	NPN break function (NC)	-25 ... +100 °C	IP 69K (sensing face/sensor)	-	< 100 mA
IFRD 08P17A1/S35L	PNP make function (NO)	-25 ... +75 °C	IP 68/67 (sensing face/sensor)	3 port LED red	< 200 mA
IFRD 08P17T1/S35	PNP make function (NO)	-25 ... +100 °C	IP 69K (sensing face/sensor)	-	< 100 mA
IFRD 08P37A1/S35L	PNP break function (NC)	-25 ... +75 °C	IP 68/67 (sensing face/sensor)	3 port LED red	< 200 mA
IFRD 08P37T1/S35	PNP break function (NC)	-25 ... +100 °C	IP 69K (sensing face/sensor)	-	< 100 mA